



EURO VISTA SLIDE™

IMPACT RATED LIFT & SLIDE DOORS WITH THERMAL BREAK OPTION

Approved for use in Miami-Dade HVHZ Zones
Florida Building Code Approved
Product Approval FL 17999

www.euro-wall.com
888.989.EURO (3876)

euro-wall®



FOLDING



SLIDING



STACKING



PIVOT

SYSTEM THRESHOLDS

Maximum / Minimum Specifications

Max Panel Weight:	500 lbs each panel
Min Panel Width:	24"
Max Panel Width:	96"
Min Panel Height:	32"
Max Panel Height:	166"
Panel Thickness:	1.75"
Max # of Panels:	8

NOTE: When using maximum panel widths & heights, panels may exceed maximum panel weight of 500 lbs. Calculated weight check should be done. For installations in Florida, please see the Florida Product Approval for usage and limitations.

SYSTEM HIGHLIGHTS

Extrusions

Extruded aluminum 6063-T5 with door panel corner keys for strength and security

Hardware

Stainless steel, steel components with corrosion resistant material - salt spray tested 500 hours

Flush or Low Profile Sill

Flush track with finished floor height or 3/8" exposed track - no sill riser required for water

Hidden Pockets

Pocket configuration option allows panels to slide into the wall, completely disappearing from view

U Factor

Lowest U factor for any available impact rated lift and slide panel

Track Options

2 track - 6 track options for flexible panel configurations

Matching Fixed Units

Florida Product Approved impact rated transom and sidelight units available

Largest Impact Rated Panel Sizes

Thermal and non-thermal 13'+ tall panels - the largest HVHZ impact tested and Florida Product Approved lift and slide panels available

Thermally Broken Option

Impact rated thermally broken panel option - the largest impact tested thermally broken panels available

Aesthetics

Wood cladding option available

Corner Units

90° postless corner units (all impact tested / Florida Product Approved)

Long Lasting Finish

AAMA 2605 coating is the standard finish

Under Pressure

Up to 15 lbs of water protection without sill riser

Unhindered View

Highest glass to frame ratio available

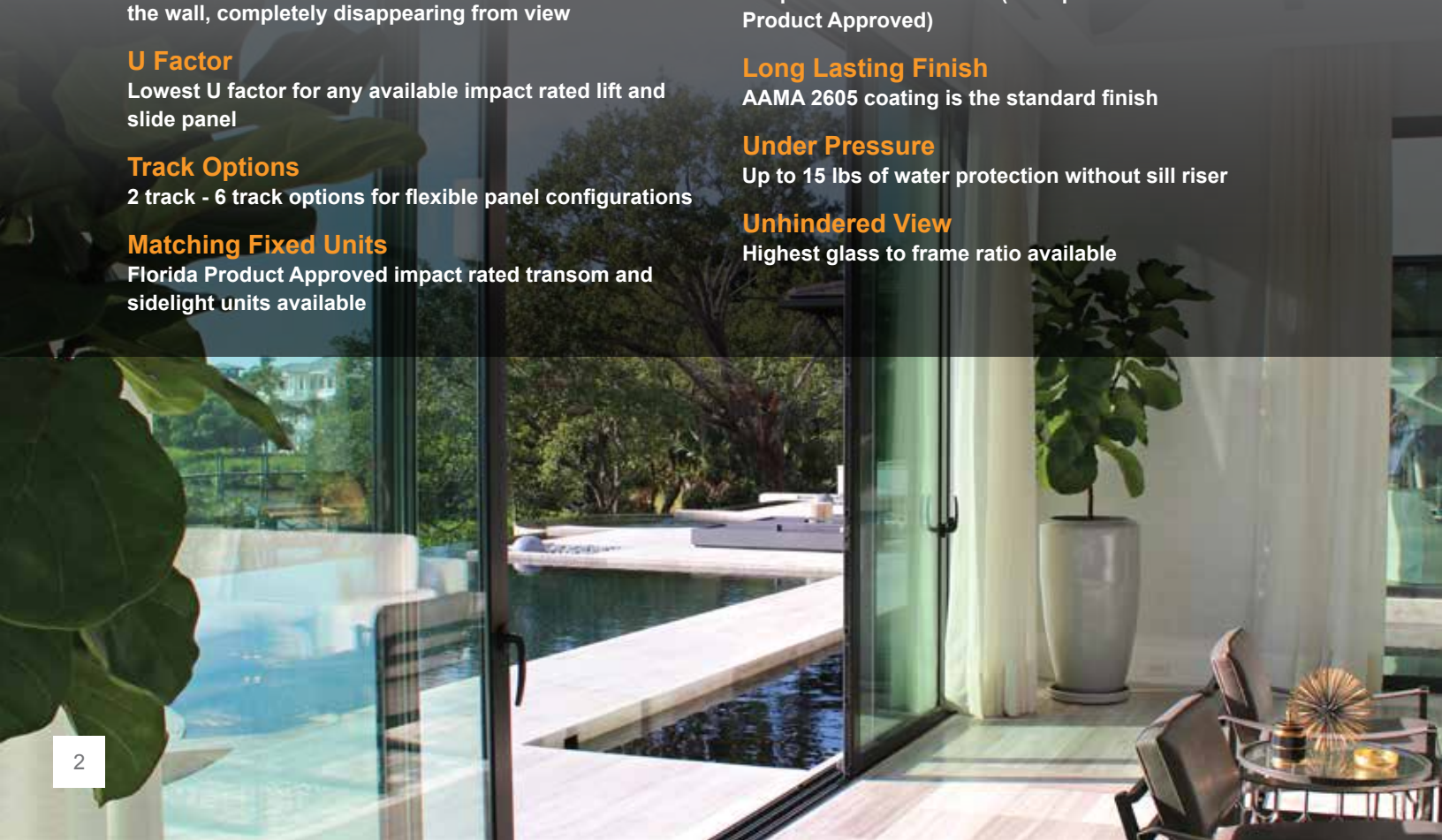

SYSTEM COMPONENTS

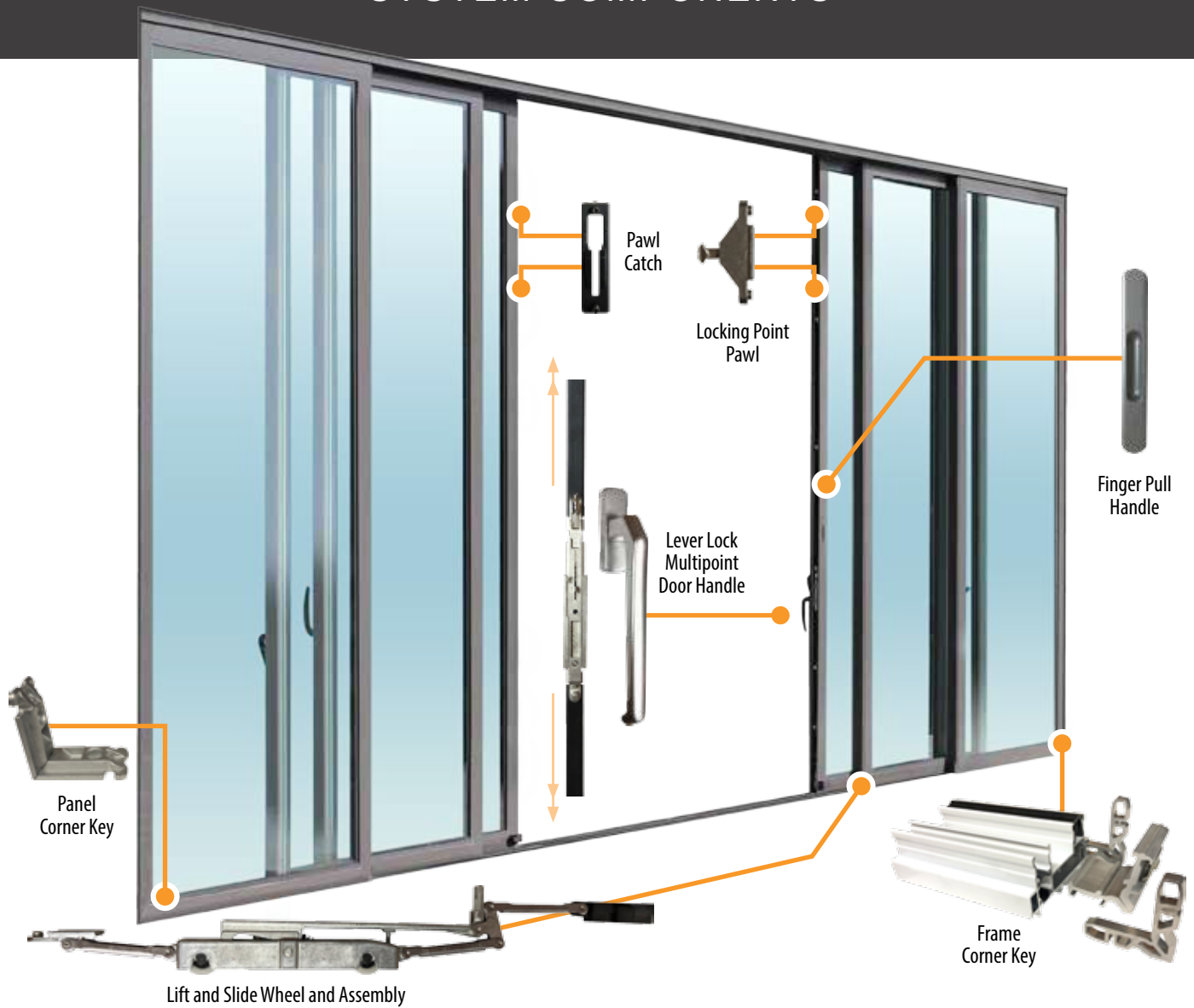

TRACK OPTIONS

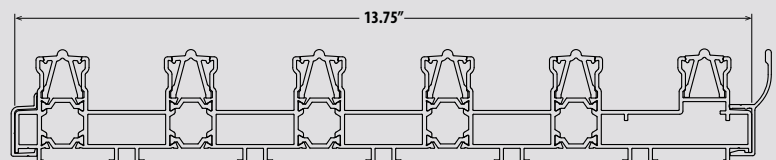
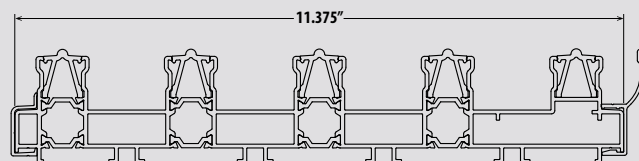
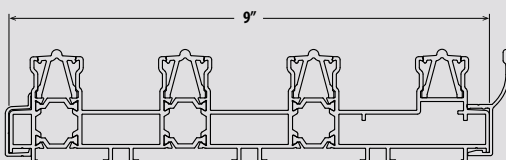
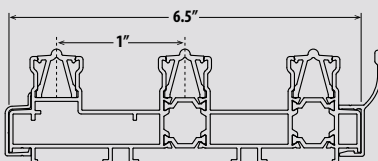
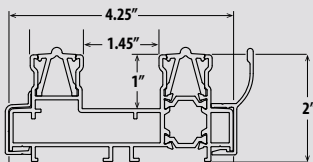

The Euro Vista Slide comes in a 2 track, 3 track, 4 track, 5 track or 6 track configuration. Your selection will depend on the number of total panels, the number of operable panels and the direction of the panel opening(s) / closure(s). A Euro-Wall project manager can help you select the right track configuration for your specific project.

PANEL FINISH OPTIONS

STANDARD FRAME & DOOR PANEL FINISHES

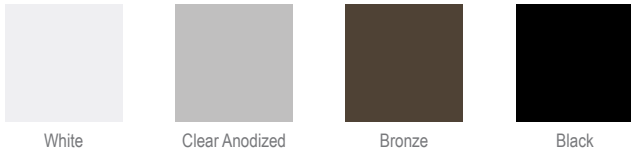

White

Clear Anodized

Bronze

Black

STANDARD FRAME & DOOR PANEL FINISHES

- Anodized, powder coat or Kynar® finishes available
- Custom powder coat or Kynar® finishes available
- Manufacturer color match options
- 40 Custom wood grain finishes available

INTERIOR WOOD CLAD FINISH OPTION

- Douglas Fir
- Mahogany / Sapele
- White Oak



HARDWARE / HANDLE FINISH OPTIONS

MULTIPOINT LOCK HANDLE



Available Finishes
Brushed Satin
Bronze
White
Custom Color

TRACK / FRAME



Available Finishes
Clear Anodized
White
Bronze / Black
Custom Color

GLAZING OPTIONS

Available glass for the Euro Vista Slide are:

- Insulated Glass
- Impact Insulated Glass

SUPERIOR BY DESIGN

CONFIGURATION SAMPLES

O = FIXED PANEL X = ACTIVE PANEL

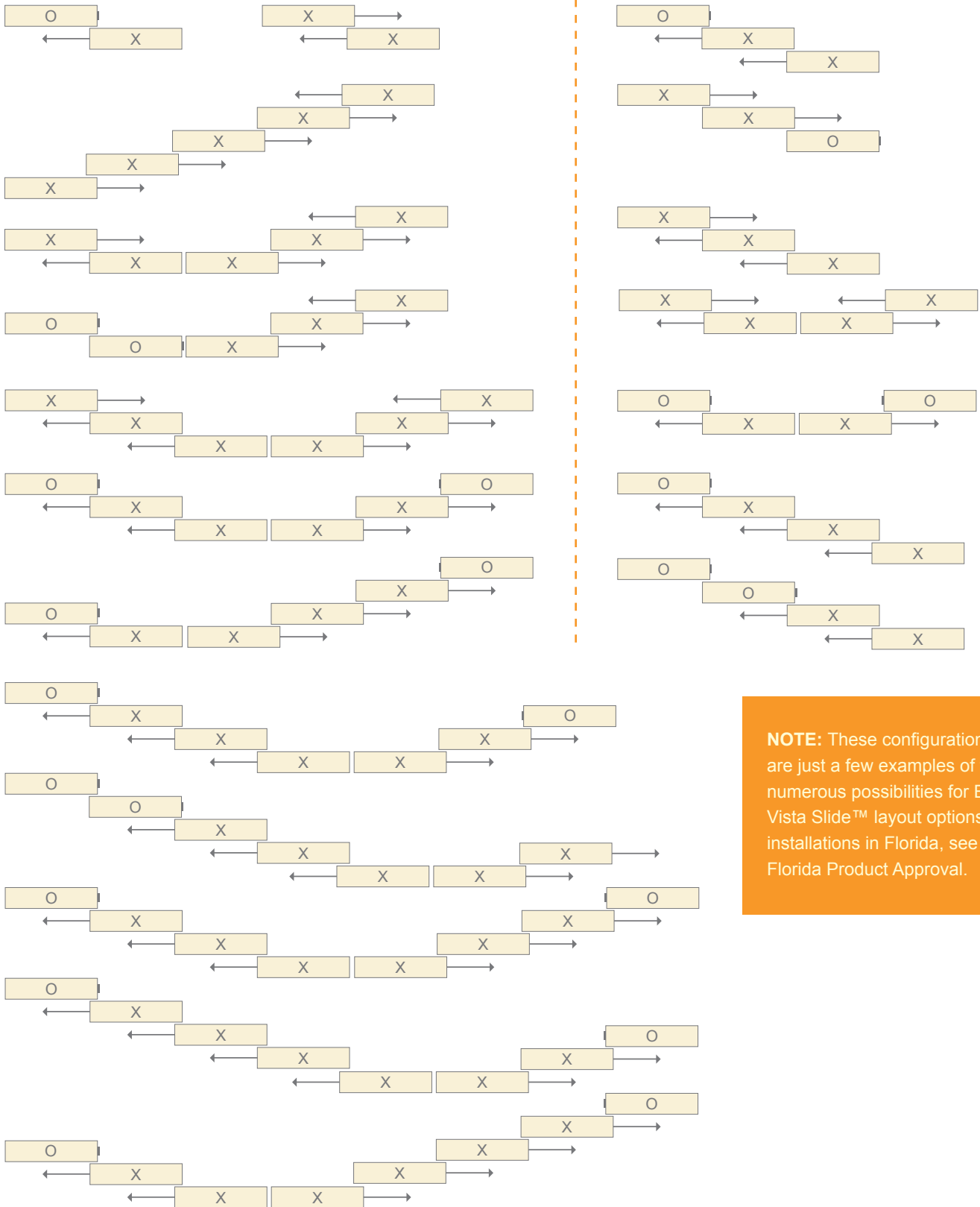

NOTE: These configurations are just a few examples of the numerous possibilities for Euro Vista Slide™ layout options. For installations in Florida, see the Florida Product Approval.

EURO VISTA SLIDE™ SILL PROFILE DETAILS

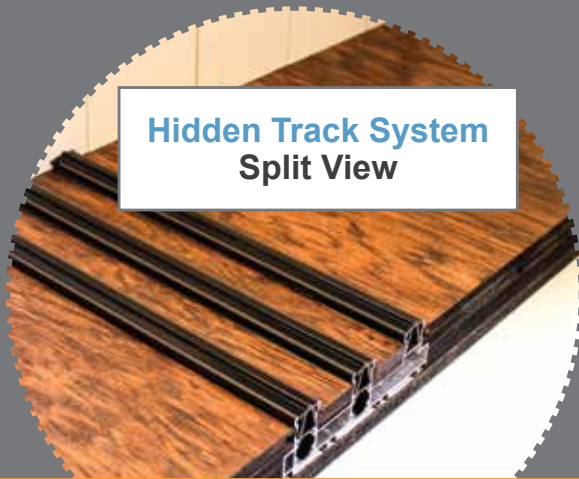

**Hidden Track System
Split View**

NON-THERMALLY BROKEN & THERMALLY BROKEN PANEL OPTIONS

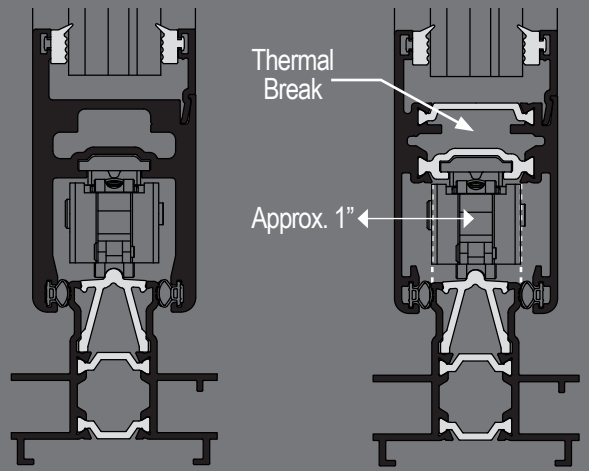

**Non-Thermally
Broken Panel Detail**

**Thermally Broken
Panel Detail**

For weather challenged climates, the flush and low profile hidden track systems can be manufactured to meet and exceed water rating specifications. Additionally, Euro-Wall EXCLUSIVELY manufactures a water rated hidden flush sill.

FLUSH SILL

**Hidden Track System
Cross Section**



Finish Floor
↓

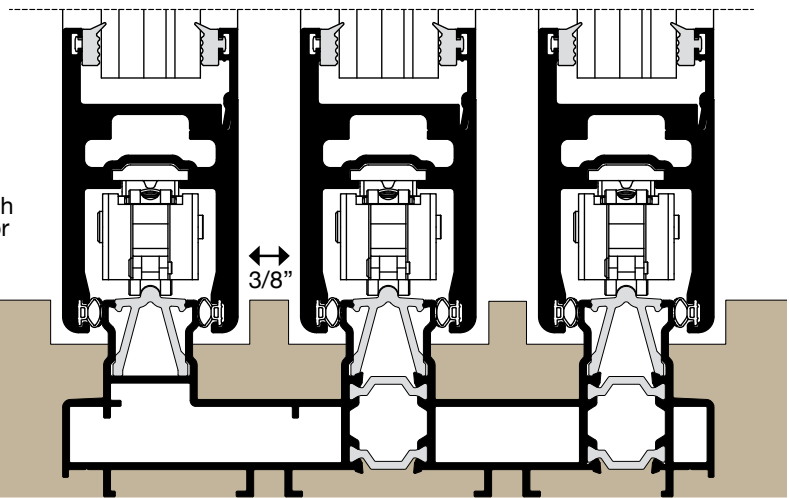

LOW PROFILE SILL

**Hidden Track System
Cross Section**

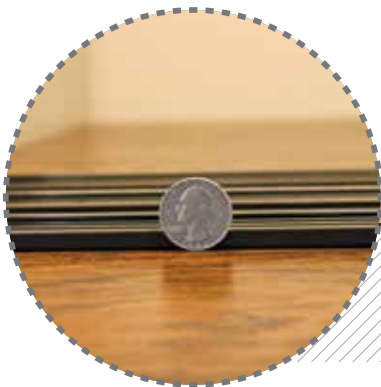

Finish Floor
↓

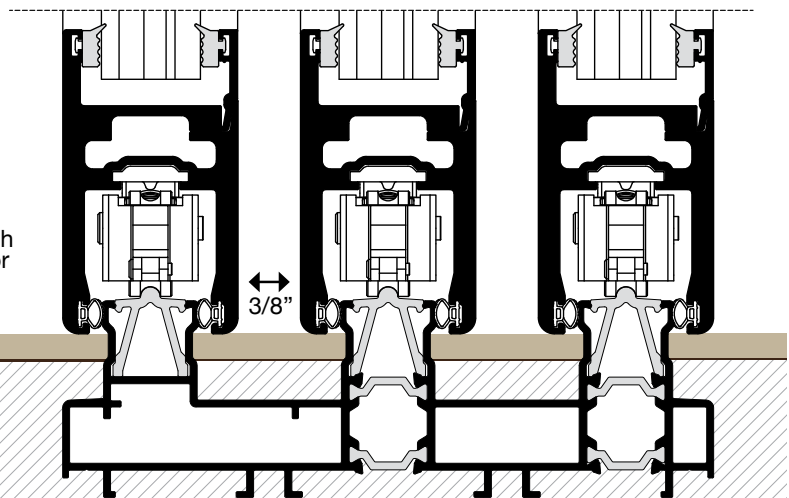

TEST PERFORMANCES

- Approved for use in Miami-Dade HVHZ Zones
- Florida Building Code Approved
Product Approval FL 17999
- California Title 24 Compliant
- AAMA 440 - PASS
- ASTM 330 - PASS
- NAFS - 08 - PASS
- WDMA/CSA101 - PASS
- DP50 to DP75
- Tested for use in Florida
- Impact 1886 & 1996
- TAS 201, 202, 203 (Miami Dade)
- NFRC Tested for Thermal Requirements

DESIGN PRESSURE CHART

		Panel Width (Inches)										
		30	32	36	40	44	48	50	56	60	66	72
Panel Height (Inches)	72	75.0	75.0	75.0	75.0	75.0	75.0	75.0	75.0	75.0	60.0	60.0
	78	75.0	75.0	75.0	75.0	75.0	75.0	75.0	75.0	60.0	60.0	60.0
	84	75.0	75.0	75.0	75.0	75.0	75.0	75.0	60.0	60.0	60.0	60.0
	90	75.0	75.0	75.0	75.0	75.0	75.0	75.0	60.0	60.0	60.0	60.0
	96	75.0	75.0	75.0	75.0	75.0	60.0	60.0	60.0	60.0	60.0	60.0
	102	75.0	75.0	74.6	67.9	62.6	60.0	60.0	60.0	60.0	60.0	
	108	69.9	65.8	60.0	60.0	60.0	60.0	60.0	60.0	60.0	60.0	
	114	60.0	60.0	60.0	60.0	60.0	60.0	60.0	60.0	60.0		
	120	60.0	60.0	60.0	60.0	60.0	60.0	60.0	60.0	60.0		
	126	60.0	60.0	60.0	60.0	60.0	59.2	57.1	51.8			
	132	60.0	59.5	60.0	57.7	52.9	48.9	47.1				
	138	60.0	59.5	53.2	48.2	44.1	40.7	39.3				
	144	53.3	50.1	44.8	40.5	37.1	34.2	33.0				
	150	45.2	42.5	37.9	34.3	31.4	29.0					
	156	38.6	36.3	32.4	29.3	26.8						
	162	33.2	31.1	27.8	25.1	23.0						

Product Approval FL 17999



EURO-WALL 10 YEAR WARRANTY

Euro-Wall warrants the products to be free from manufacturing defects for a period of 10 years from the date of purchase.

888.989.EURO (3876)

www.euro-wall.com

euro-wall[®]

FOLDING | SLIDING | STACKING

MANUFACTURING

2200 Murphy Court
North Port, Florida 34289
888.989.3876 • 941.979.5316

SHOWROOM

1211 Stirling Road, Unit 102,
Dania Beach, Florida 33004
954.610.2572

Proud Member of the American Architectural Manufacturers Association.

